

### Features

- ESD protection for high speed data lines to IEC61000-4-2
- ESD contact discharge typical 8KV, max 30KV
- ESD air discharge typical 15KV, max 30KV
- Surface mount
- Extremely low capacitance
- Very low leakage current
- Fast response time
- Bi-directional ESD protection
- Lead free solder termination
- The best ESD protection for high frequency, low voltage applications

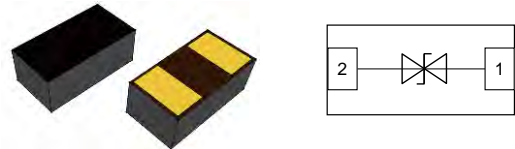

### Mechanical Data

- **Case:** P6H (plastic package).  
Lead free; RoHS compliant; Halogen free
- **Molding Compound Flammability Rating:**  
UL 94 V-0
- **Terminals:** High temperature soldering guaranteed:  
260 °C/10 sec. at terminals

### Applications

- USB3.0, Firewire, DVI, HDMI, S-ATA
- Thunderbolt, Display Port
- Mobile HDMI Link, MDDI, MIPI, SWP / NFC



Caution:  
This component is designed for signal line protection only,  
Not intended to be used under bias, not for application with  
a power line.

### Absolute Maximum Ratings

Ratings at 25 °C, ambient temperature unless otherwise specified

Parameter	Symbol	Value	Unit
Maximum Contact discharge voltage Per IEC61000-4-2	---	30KV	V
Maximum Air discharge voltage Per IEC61000-4-2	---	30KV	V
Maximum Operating temperature	T <sub>OPER</sub>	-40 to +125	°C
Maximum Storage temperature	T <sub>STG</sub>	-55 to +125	°C
Maximum lead temperature for soldering during 10s	T <sub>L</sub>	260	°C

### Electrical Characteristics

(T<sub>A</sub> = 25 °C unless otherwise specified)

Parameter	Symbol	Test Conditions	Min	Typ	Max	Units
Rated Voltage	V <sub>R</sub>	---			11	V
Trigger voltage	V <sub>T</sub>	IEC61000-4-2 8KV contact discharge	---	350	---	V
Clamping voltage	V <sub>C</sub>	IEC61000-4-2 8KV contact discharge	---	35	---	V
Leakage current	I <sub>L</sub>	DC 12V shall be applied on component	---		0.10	uA
Capacitance	C <sub>P</sub>	V <sub>R</sub> = 0V, f = 1MHz	---	0.05		pF

Note: 1 Trigger and clamping voltage are measured per IEC 61000-4-2, 8KV contact discharge method.

2 After reliability tests such as high temp storage, temp cycles, continuous ESD strike etc, the maximum leakage current is less than 10uA.

### ESD Clamping Test

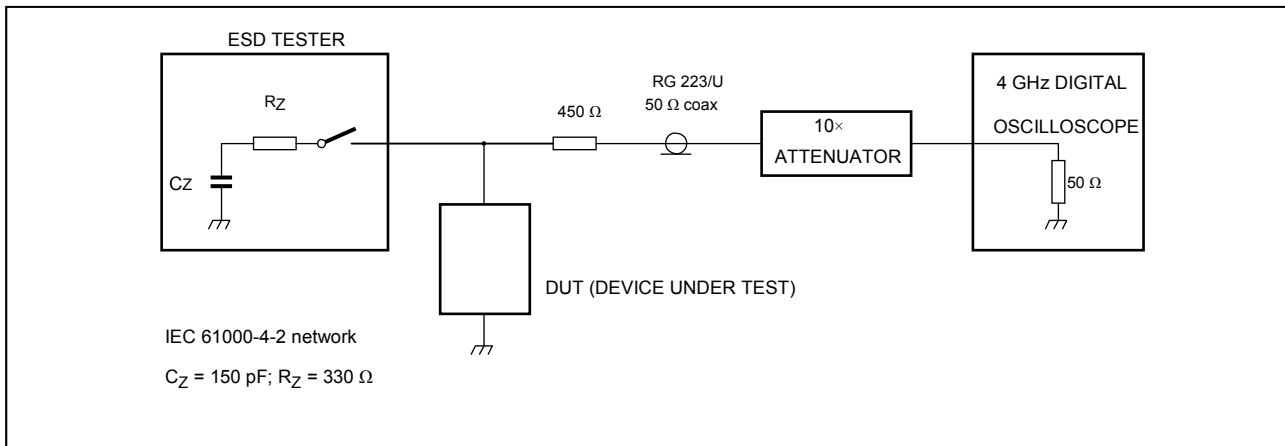

### Typical Characteristics

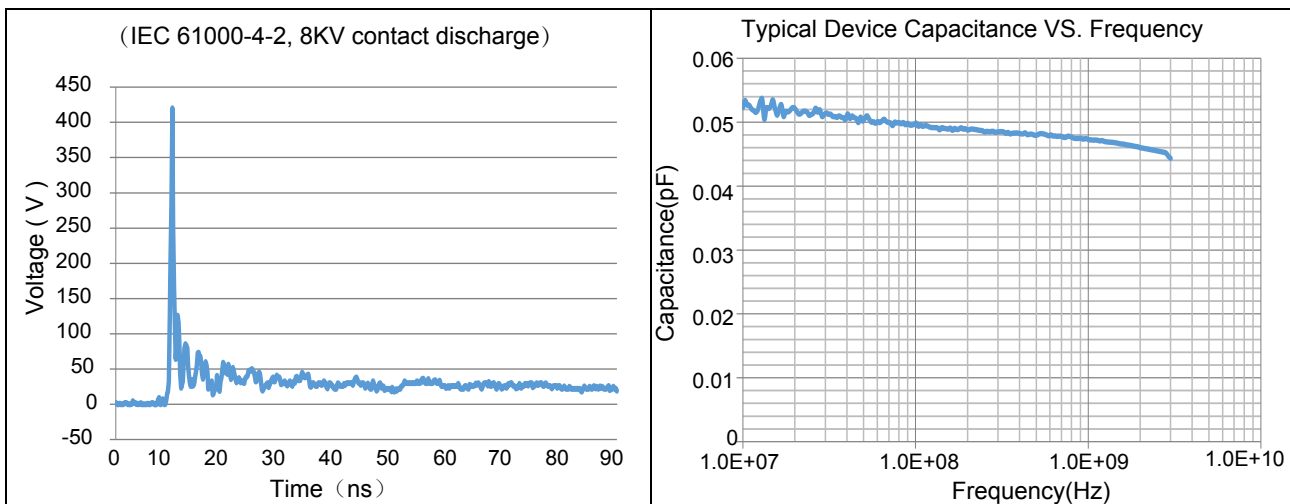

### ESD Protection for Signal Line

The CESD is designed for the protection of one bidirectional data line from ESD damage.

- Place the CESD as close to the input terminal or connector as possible.
- Minimize the path length between the CESD and the protected signal line.
- Use ground planes whenever possible.

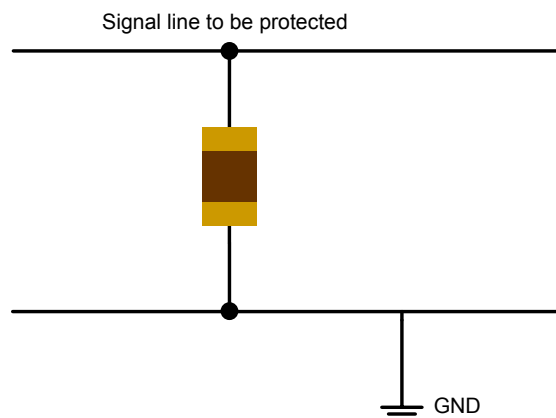

**Product Dimension**

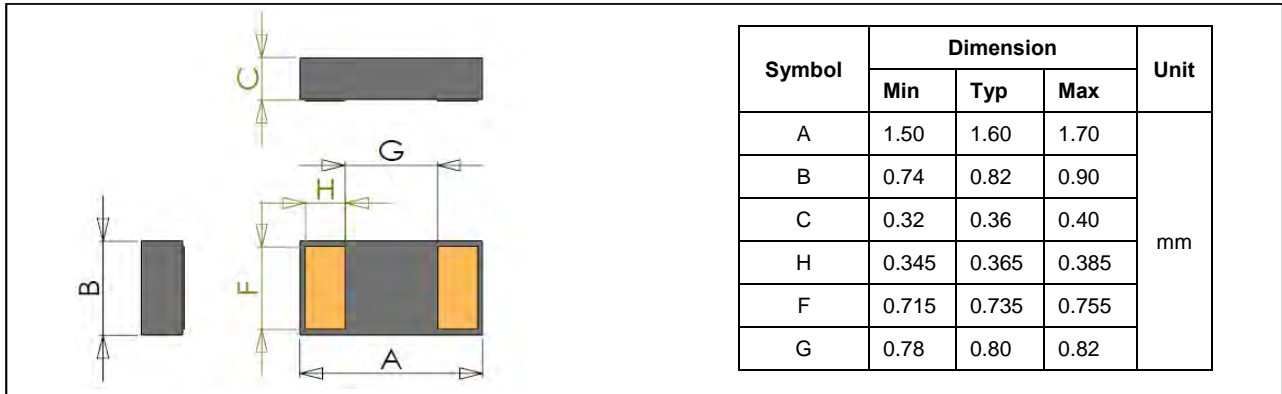

**PAD Dimension**

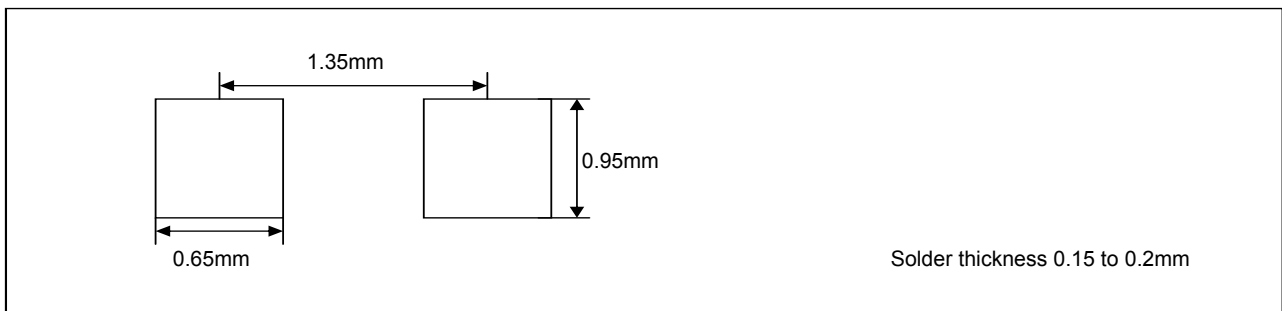

**Solder Reflow Recommendations**

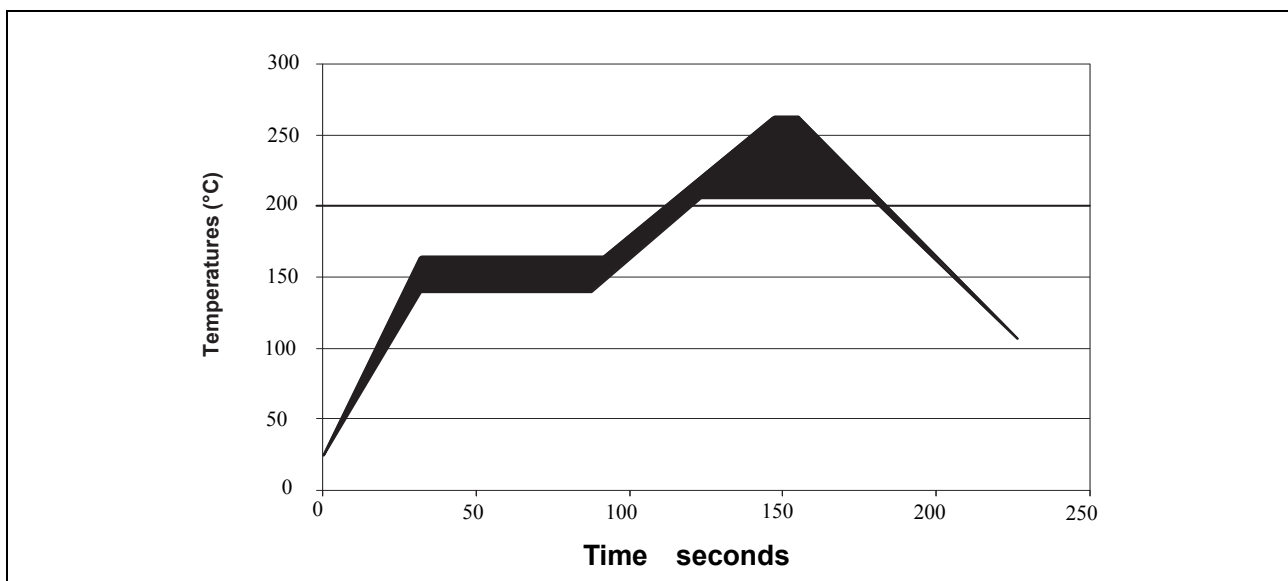

**Package Information**

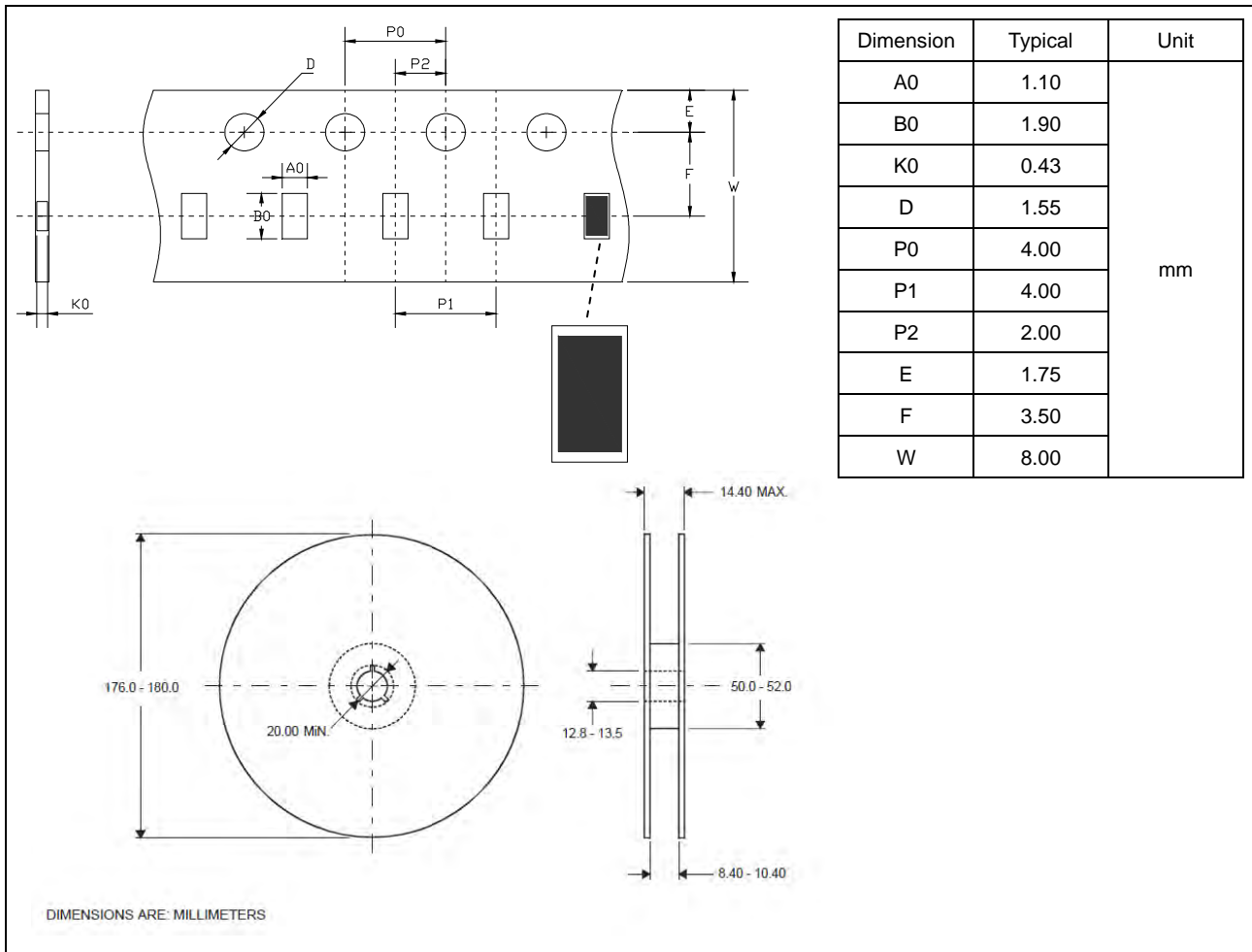

**Ordering information**

Order code	Package	Packaging option	Base quantity	Packaging specification
YEUP06211R05B	P0603	Tape and reel	5000pcs / reel	EIA STD RS-481